

Mini Relay K (Open – Sealed)

- Limiting continuous current 20A
- 24VDC coil versions available

Typical applications

Car alarm, hazard warning signal, heated rear screen, immobilizer, lamps front/rear, fog light, interior lights, sun roof, turn signal, wiper control.

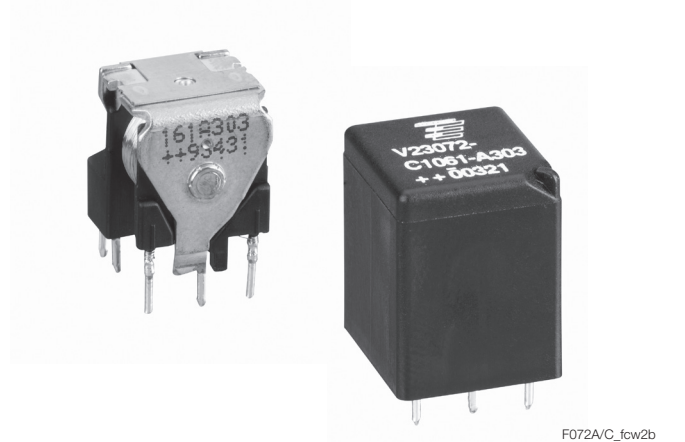

Contact Data

Load	resistive/inductive load V23072-C10**-A302	resistive/inductive load V23072-C10**-A303	resistive/inductive load V23072-C10**-A308	head/indicator lamp V23072-C1061-A402	head/indicator lamp V23072-C1061 A408
Contact arrangement	1 form A, 1 NO	1 form C, 1 CO	1 form U/X, 2 NO	1 form A, 1 NO	1 form U/X, 2 NO
Rated voltage	12VDC	12VDC	12VDC	12VDC	12VDC
Rated current	15A	10/15A	2x10A	12A	2x6A
Limiting continuous current					
23°C	15A	10/15A	2x10A	12A	2x6A
85°C	10A	5/10A	2x6A	10A	2x5A
Limiting making current ¹⁾²⁾	60A	NC/NO 12/60A	2x40A	60A ³⁾	120A ³⁾
Limiting breaking current	20A	10/20A	2x20A	6A	12A
Contact material	AgNi0.15	AgNi0.15	AgNi0.15	AgSnO.2	AgSnO.2
Min. recommended contact load ⁴⁾	1A at 5VDC	1A at 5VDC	1A at 5VDC	1A at 5VDC	1A at 5VDC
Initial voltage drop at 10A, typ./max. 150/300mV		50/300mV	50/300mV	2x50/300mV	150/300mV
Operate/release time max.			typ. 3/1.5ms ⁵⁾		
Electrical endurance	>2x10 ⁵ ops. at 13.5VDC, 10A	>2x10 ⁵ ops. at 13.5VDC, 10A	>2x10 ⁵ ops. at 13.5VDC, 10A	>1x10 ⁶ ops. up to 6x21W >1.5x10 ⁵ ops. 100A (on), 10 A (off) high beam	>1.5 x 10 ⁶ ops. up to 6x21W >7.5x10 ⁵ ops. 100A (on), 10A (off) high beam

- 1) The values apply to a resistive load or inductive load with suitable spark suppression and at maximum 13.5VDC for 12VDC and 27VDC for 24VDC load voltages.
- 2) For a load current duration of maximum 3s for a make/break ratio of 1:10.
- 3) Corresponds to the peak inrush current on initial actuation (cold filament).
- 4) See chapter Diagnostics of Relays in our Application Notes or consult the internet at <http://relays.te.com/appnotes>
- 5) For unsuppressed relay coil. A low resistive suppression device in parallel to the relay coil increases the release time and reduces the lifetime caused by increased erosion and/or higher risk of contact tack welding (monostable version only).

Max. DC load breaking capacity

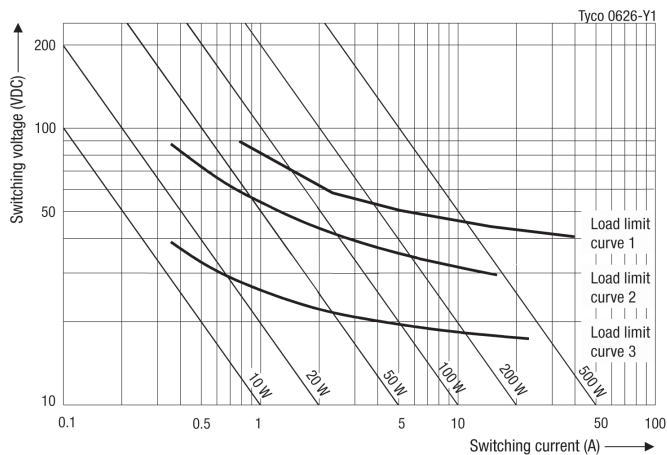

Load limit curve 1: safe shutdown, connected as form X, load on pin 5 and 7.
 Load limit curve 2: safe shutdown, no stationary arc (NO contact).
 Load limit curve 3: arc extinguishes during transit time (CO contact).
 Load limit curves measured with low inductive resistors verified for 1000 switching events.

Mini Relay K (Open – Sealed) (Continued)

Coil Data

Rated coil voltage	12VDC, 24VDC
--------------------	--------------

Coil versions, DC coil

Coil code	Rated voltage VDC	Operate voltage VDC	Release voltage VDC	Coil resistance $\Omega \pm 10\%$	Rated coil power W
061	12	6.9	1.2	130	1.1
062	24	14.1	2.4	520	1.1

All figures are given for coil without pre-energization, at ambient temperature +23°C.

Coil operating range

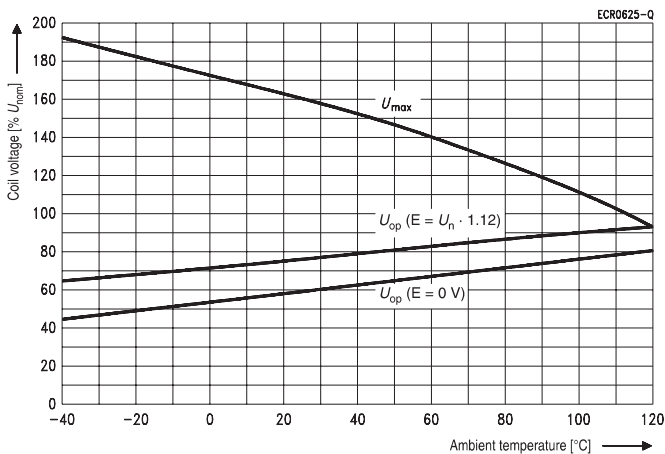

Does not take into account the temperature rise due to the contact current
E = pre-energization.

Terminal Assignment (Open and Sealed version)

Bottom view on solder pins

1 form A, NO

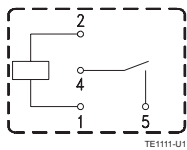

TE1111-U1

1 form U/X, 2 NO

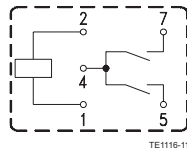

TE1116-11

1 form C, CO

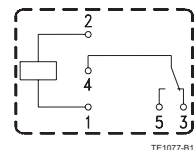

TE1077-B1

Other Data

EU RoHS/ELV compliance	compliant	
Degree of protection	IEC 61810	
	RT II – open (V23072-A),	
	RT III – imm. cleanable (V23072-C)	
Climatic cycling with condensation	EN ISO 6988	
	20 cycles, storage 8/16h	
Temperature cycling (shock)	IEC 60068-2-14, Na	
	720 cycles, -40/+85°C (dwell time 1h)	
Damp heat constant	IEC 60068-2-3, Ca	
	56 days, upper air temperature 55°C	
Corrosive gas	IEC 60068-2-42	
	10 days	
	IEC 60068-2-43	
	10 days	
Vibration resistance (functional)	IEC 60068-2-6 (sine sweep), 10 to 200Hz,	
	23 to 35g ⁶⁾	
Shock resistance (functional)	IEC 60068-2-27 (half sine), 4 to 6ms	
	23 to 280g ⁶⁾	
Terminal type	PCB	
Weight, open/sealed	approx. 8/9g (0.28/0.32oz)	
Solderability (aging 3: 4h/155°C)	IEC 60068-2-20	
	Ta, method 1, hot dip 5s, 215°C	
Sealing, IEC 60068-2-17	Qc, method 2, 1min/70°C	
Storage conditions	according IEC 60068 ⁷⁾	
Packaging unit	open	
	600 pcs.	
	sealed	
	504 pcs.	

6) Values weakest direction. Depending on mounting position: no change in the switching state >10µs.

7) For general storage and processing recommendations please refer to our Application Notes and especially to Storage in the Definitions or at <http://relays.te.com/appnotes/>

Mini Relay K (Open – Sealed) (Continued)

Dimensions

Mini Relay K Open Version

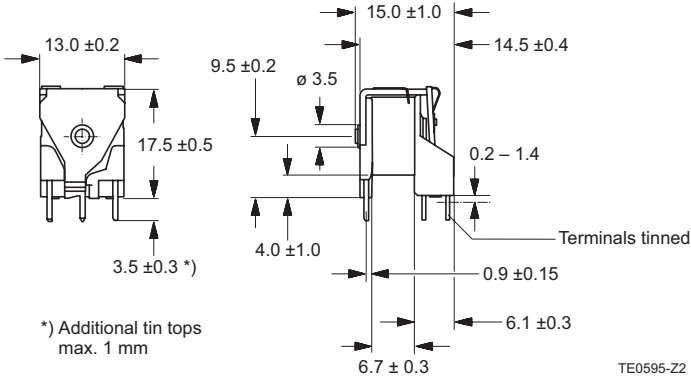

Mini Relay K Sealed Version

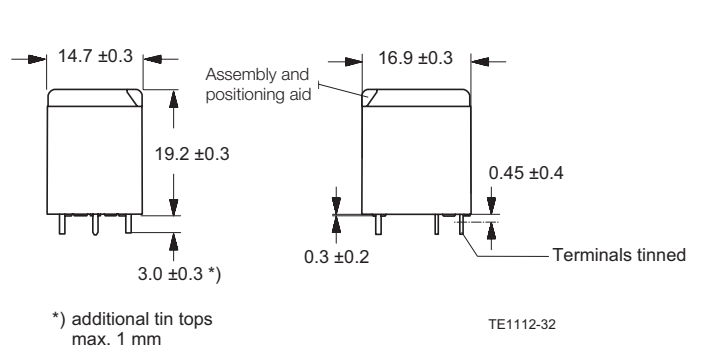

View of the terminals (bottom view)

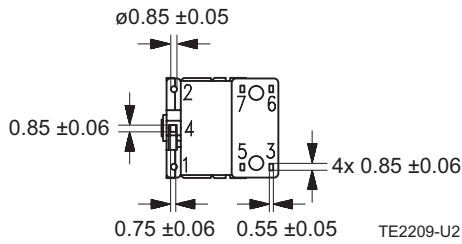

View of the terminals (bottom view)

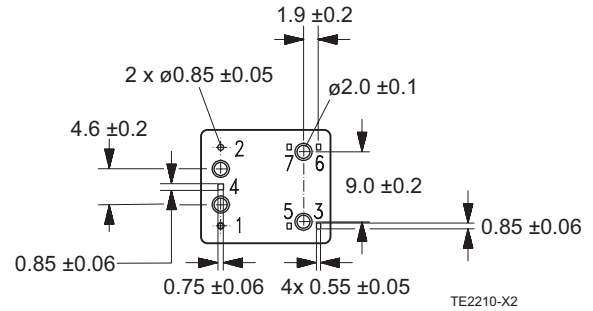

PCB Layout

Bottom view on solder pins, grid 1.25 to 1.27mm

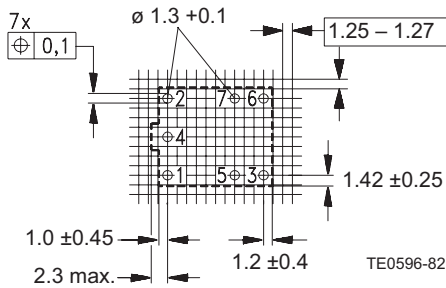

PCB Layout

Bottom view on solder pins, grid 1.25 to 1.27mm

